

# GYPSE GLASS

FRAMELESS GLASS

BALUSTRADE



Architect: Morris Architects  
Photographer: Andy Le Gresley



By  Hydro





**Architect:** White Architects  
**Photographer:** Lindman Photography





# GYPSE GLASS

## / FRAMELESS BALUSTRADE

### GYPSE GLASS, A MINIMAL BALUSTRADE

The GYPSE GLASS balustrade, is a frameless balustrade designed to provide protection discreetly without blocking or disturbing the view.

The GYPSE GLASS is very light on the façade and integrates elegantly with the building elements and seamlessly with the surrounding.

The minimal design and finishes variety meet the needs of all market sectors, whether for new buildings or renovations. It is suitable for residential applications, service locations, reception areas and crowded places.

### GYPSE GLASS, A SUSTAINABLE SOLUTION

Aluminum and glass are corrosion resistant materials and both fully recyclable, which combined offer a sustainable balustrading solution suited to diverse project situations – facades, atria, etc.

The GYPSE system carries several certificates ensuring full compliance with standards and regulations.

### GYPSE GLASS, A FIRM STRUCTURE

The GYPSE system consists of a set of aluminum profiles and accessories:

- Continuous base rail
- Extruded aluminium profile
- Accessories in ABS, PVC and EPDM

The base profile can either be U shaped or L shaped depending on the application, and the joints of the profile are reinforced with stainless steel pins.

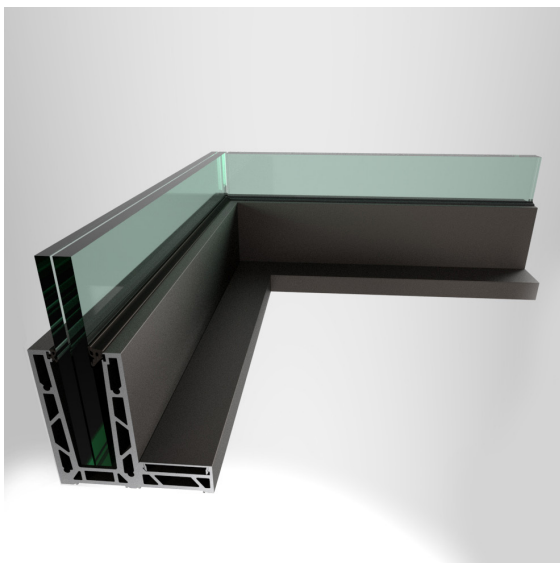

# GYPSE GLASS

/ FRAMELESS GLASS BALUSTRADE



# GYPSE GLASS

## / CHARACTERISTICS

### FIXATION

Suitable elements must be used for the fixation with the slab, with a minimum selection of M10 anchors, a maximum in-between distance of 250mm, and a minimum distance from the slab edges not less than 50mm. However, the fixation system varies depending on the density and/or thickness of the material where the guard will be installed.

### DIMENSIONS

- The connection to the slab structure is ensured through two footing possibilities, simple or advanced:
  - Continuous base rail 65mm in depth and 120mm in height, with connections at 180° using stainless steel pins. (U-shaped)
  - Continuous base rail 120 / 124mm deep and 120mm high, with connections at 180° using stainless steel pins. (L-shaped)
- The maximum height of protection above the floor finish level varies between 1.00 m for "U" base rail shape and 1.20 m for "F" base rail shape.
- Possibility of infill of 13.52mm and from 17.52mm to 27.52mm, in any of the applications (Note: for 13.52mm application, it is subject to structural verification of the glass).
- The system has two complementary anodized aluminum trim profiles for a better finish.
- Extruded aluminium profiles in Alloy 6060/6063 as per the European standard EN and in alloy 6061/6082 as per the American standard ASTM (validate structural performances with TECHNAL),
- Accessories are made of ABS, PVC and EPDM. Tops in anodised aluminum.

### APPLICATIONS

The base profile allow four methods of application:

- Top-mounted on the slab (simple)

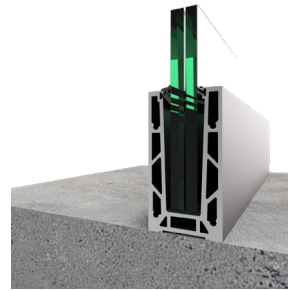

- Top-mounted on the slab with foot (advanced)

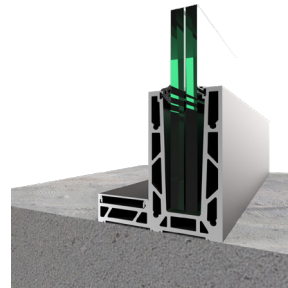

- Embedded in the slab

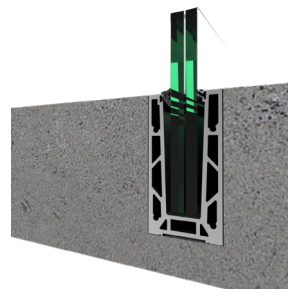

- Face-mounted on the slab edge

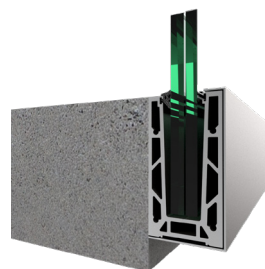

# GYPSE GLASS

## / TYPOLOGIES

TOP-MOUNTED ON THE SLAB (SIMPLE)

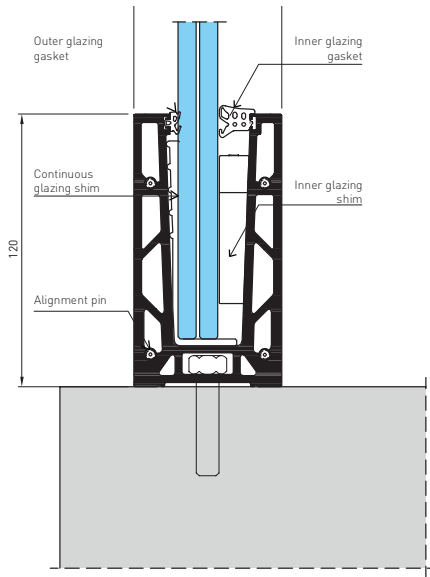

TOP-MOUNTED ON THE SLAB WITH FOOT (ADVANCED)

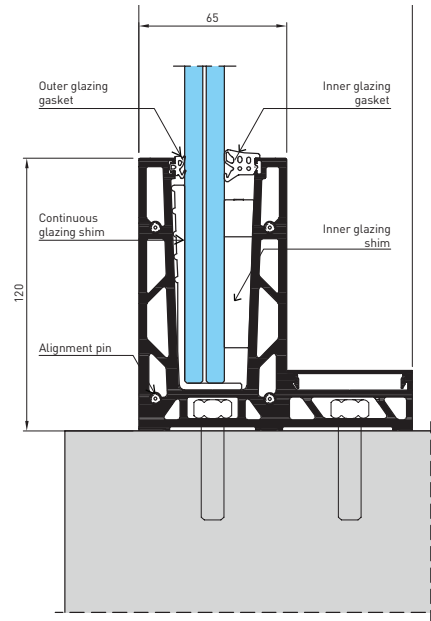

EMBEDDED IN THE SLAB

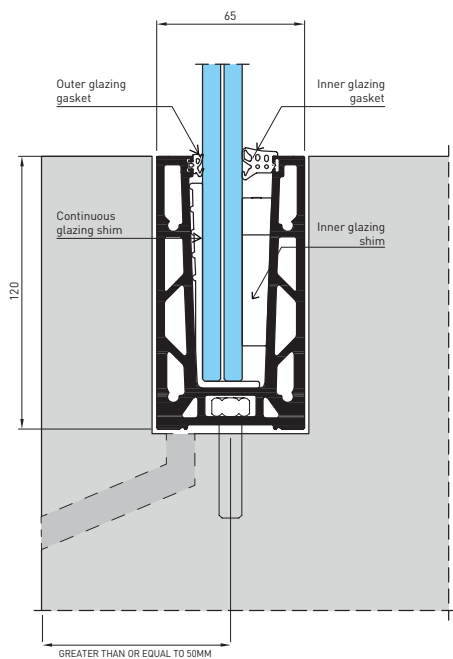

FACE-MOUNTED ON THE SLAB\*

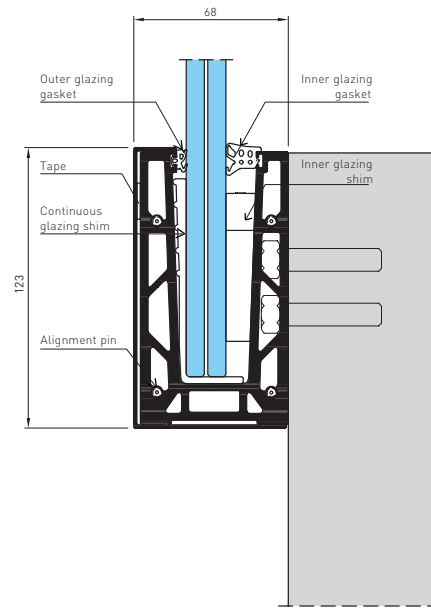

\*VALIDATE STRUCTURAL PERFORMANCES WITH TECHNICAL





NANTES 437  
DALBY DOULON  
GARE S.N.C.F.  
accès Nord

ÎLE de NANTES  
MALAKOFF  
la P<sup>re</sup> Amazonie  
mairie annexe  
-Nantes Malakoff  
maison de quartier  
des Haubans  
pôle commercial  
de l'Estuaire

BOULEVARD  
de Berlin

# APPLICATIONS

/ TYPOLOGIES

TOP-MOUNTED ON THE SLAB (SIMPLE)

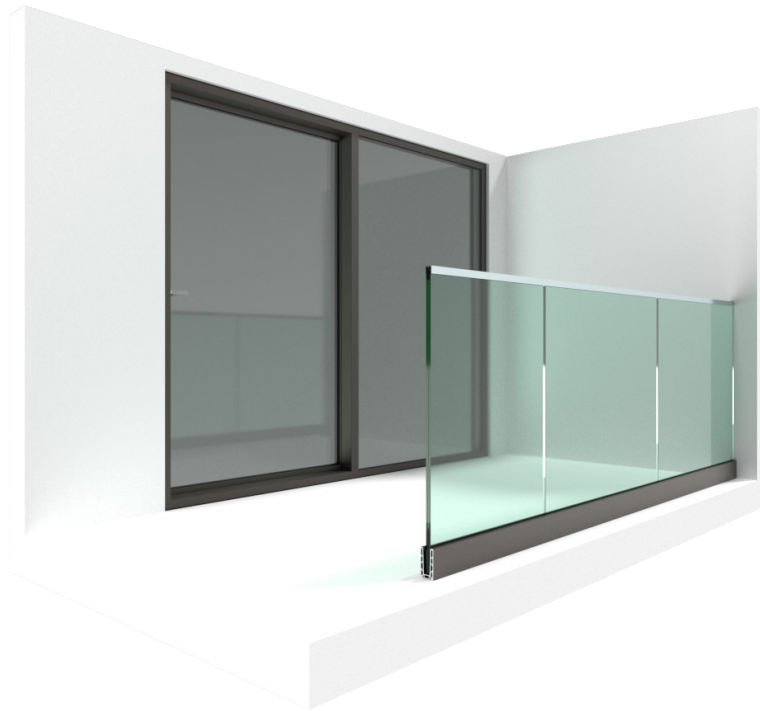

TOP-MOUNTED ON THE SLAB WITH FOOT (ADVANCED)

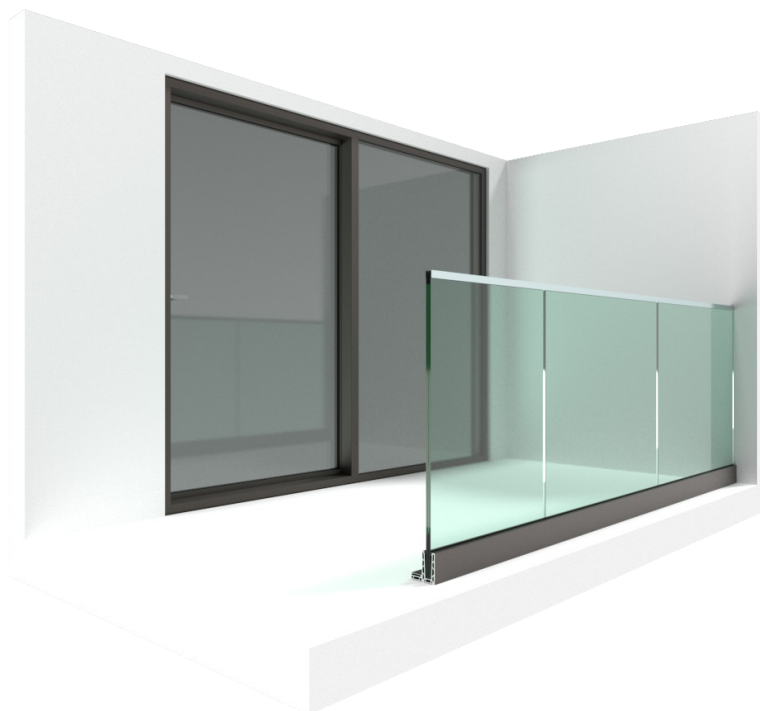



FACE-MOUNTED ON THE SLAB\*

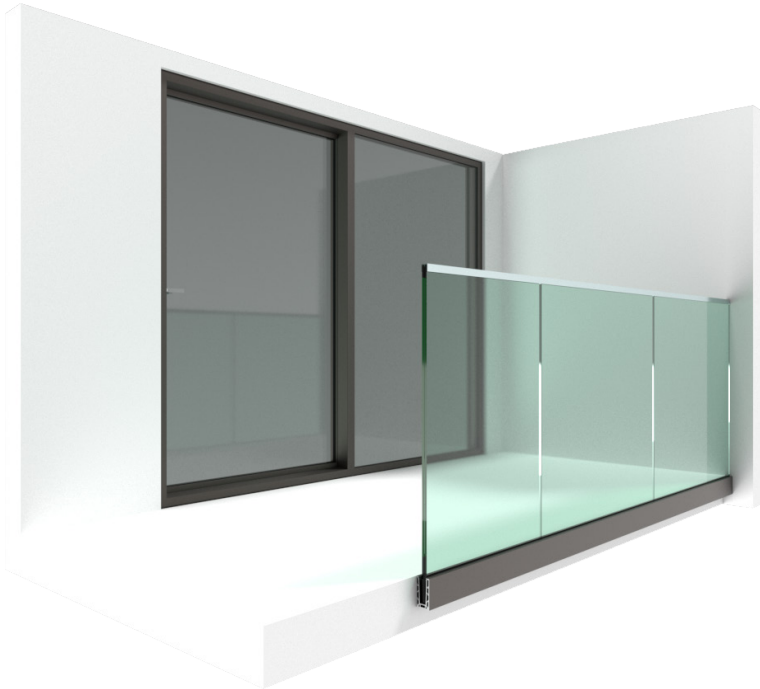

EMBEDDED IN THE SLAB

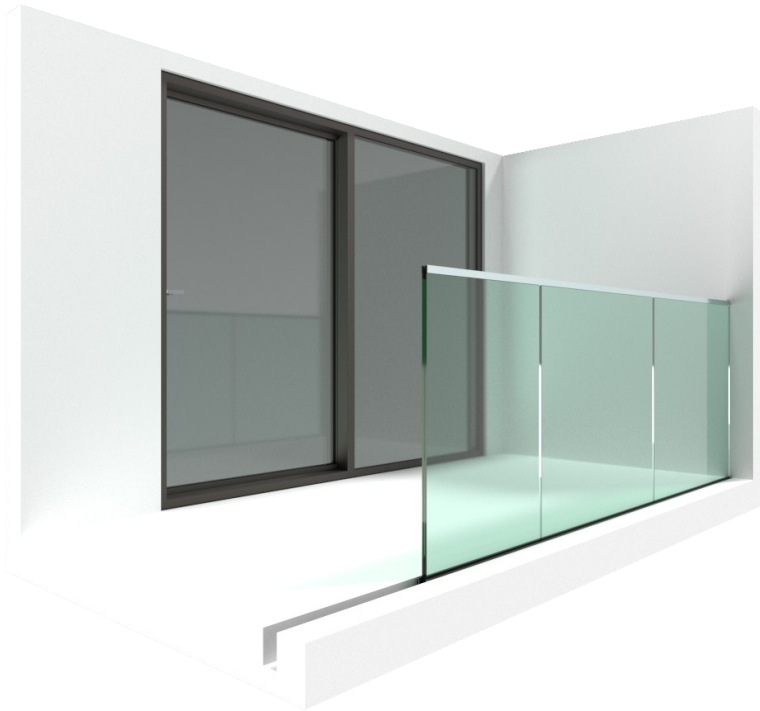

\*VALIDATE STRUCTURAL PERFORMANCES WITH TECHNICAL

# APPLICATIONS

## / NORMS AND STANDARDS

According to the British standard BS 6180:2011, the balustrades must be tested with the loads defined for the places and type of use foreseen, namely:

BRITISH STANDARD BS 6180:2011				
Type of occupancy for part of the building or structure	Examples of specific use	Horizontal uniformly distributed line load (kN/m)	Uniformly distributed load applied to the infill (kN/m <sup>2</sup> )	A point load applied to part of the infill (kN)
Domestic and residential activities	- All areas within or serving exclusively one single family dwelling including stairs, landings, etc. but excluding external balconies and edges of roofs.	0.36	0.5	0.25
	- Other residential, i.e houses of multiple occupancy and balconies, including Juliette balconies and edges of roofs in single family dwellings	0.74	1.0	0.5
Office and work areas not included elsewhere, including storage areas	- Areas not susceptible to overcrowding in office and institutional buildings, also industrial and storage buildings except as given above.	0.74	1.0	0.5
Areas without obstacles of moving people and not susceptible to overcrowding	- Stair, landings, corridors, ramps	0.74	1.0	0.5
	- External balconies including Juliette balconies and edges of roofs. Footways and pavements within building curtilage adjacent to basement/ sunken areas.	0.74	1.0	0.5

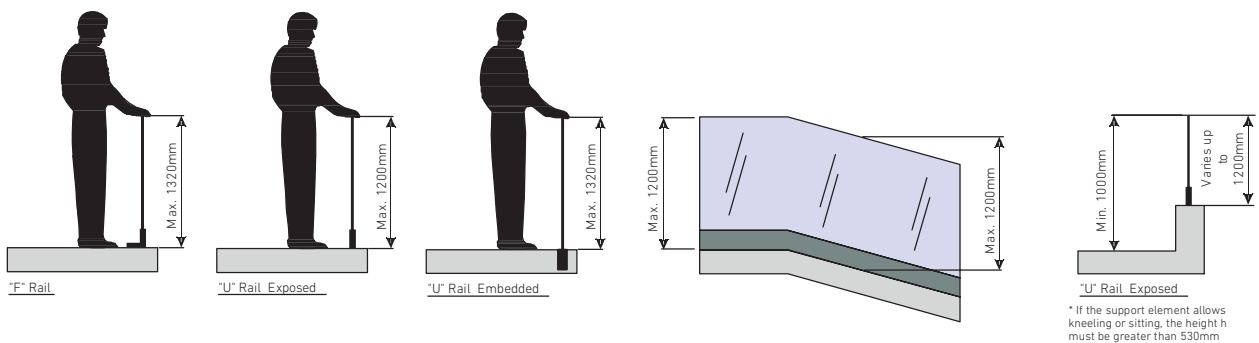



According to the American standard ASTM E 2353-16, E 985-00, the balustrades must be tested with the loads defined for the places and type of use foreseen, namely:

AMERICAN STANDARD ASTM 2352-16, E 985-00				
Type of occupancy for part of the building or structure	Examples of specific use	Horizontal uniformly distributed line load (kN/m)	Uniformly distributed load applied to the infill (kN/m <sup>2</sup> )	A point load applied to part of the infill (kN)
Residential building	- Where the railing system is installed in one or two-family dwelling units.	Class 4	ClassV 7B	Class C5
Public assembly building	- Where the railing system is installed in public assembly buildings with rooms and spaces designed for use by 50 or more persons simultaneously.	0.73	1.5	1.33
	- Where the railing system is installed in public assembly buildings with the area protected by the railing system only accessible, that is without any physical restrictions to maintenance personnel.	0.29	1.5	0.89

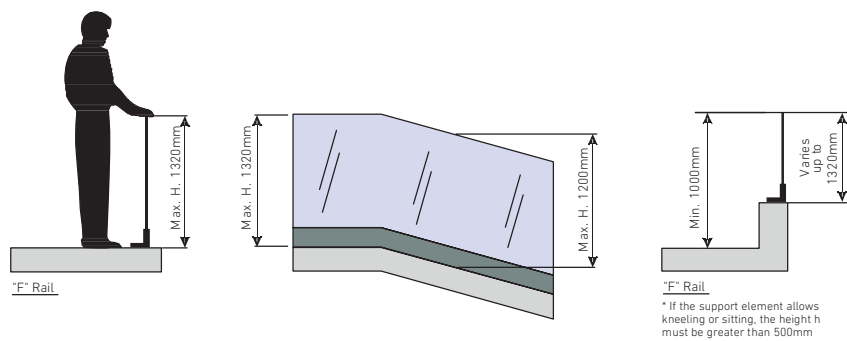

# PERFORMANCES

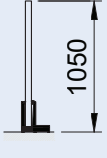
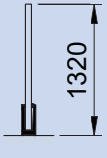
TESTS ACCORDING TO BS 6180:2011							
Test Ref. ID	Concentrated Load (Top Rail)	Linear Load (Top Rail)	Distributed Load	Impact Test	Glass (mm)	Glass composition	Typology
TBW VC162.a	0.5 kN	0.74 kN/m	1.5 KPa	✓	13.52	6mm Clear tempered glass 1.52mm Sentry glass interlayer 6mm Clear tempered glass	
TBW VL119	0.89 kN	0.74 kN/m	2 KPa	✓	21.52	10mm Clear tempered glass 1.52mm Sentry glass interlayer 10mm Clear tempered glass	

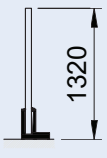
TESTS ACCORDING TO ASTM E 2353-16							
Test Ref. ID	Concentrated Load (Top Rail)	Linear Load (Top Rail)	Distributed Load	Impact Test	Glass (mm)	Glass composition	Typology
TBW VC 162.b	1.7 kN	0.74 kN/m	2 KPa	✓	21.52	10mm Clear tempered glass 1.52mm Sentry glass interlayer 10mm Clear tempered glass	





## MATERIALS AND PARTS

GYPSE GLASS, as with all TECHNAL systems, only materials and components of the highest quality are used for minimum maintenance and long-term performance.

- Aluminium profiles are extruded in Alloy 6060/6063 as per the European standard EN and in alloy 6061/6082 as per ASTM
- All gaskets are made of EPDM
- Ployamide insulating gaskets are extruded from PA6-6 (0.25 FV) and ABS
- Screw are made of stainless steel.

## COLORS AND FINISHES

A wide variety of finishes and textures are available to meet individual project requirements, complement existing buildings and offer additional design freedom for architects and specifiers:

- Anodized in accordance with EN123731: 2001
- Polyester powder coating finish in wide color range of colours in accordance with the "QUALICOAT" quality seal.
- GYPSE GLASS is also available in lacquered finishes with exclusive TECHNAL® colors for stylish and contemporary look.



IMAGINE WHAT'S NEXT

**HYDRO BS INDIA PVT LTD.**

201, 202 and 209 Prestige Meridian - 1, No. 29, M.G. Road, Bangalore 560 001

T: +91 80 46654001 | E: [contact@technal.in](mailto:contact@technal.in) | [www.technal.in](http://www.technal.in)

 [TechnalIndia](#)  [technal.india](#)  [IndiaHydro](#)  [TECHNAL India](#)